



2018 AGM Presentation

Developing strategic High Purity Alumina (HPA)
Cadoux Kaolin Project in Western Australia

FYI Presentation Outline

- FYI – HPA strategy outline
- HPA market / applications
- Key achievements in FY18
- Project outline
- Outstanding PFS results
- HPA industry engagement
- Development timeline
- Key objectives for FY19
- Summary



“HPA is one of the lesser known winners in the Battery / EV space”

CRU (2018) – Battery Commodity Report.

“World demand for high purity alumina has gained an incredible traction, owing to growing technological advancements and increasing demand from applications”

Allied Market Research (2017) – HPA Report.

FYI Resources Overview

FYI is aiming to become a dominant participant in the global HPA market



- High purity alumina (**HPA**) is aluminum oxide with a purity = / > 99.99% Al_2O_3
- HPA is experiencing immense growth and strong forecast demand
- FYI has a stated strategy of becoming a major producer of HPA
- Deriving HPA from a non-traditional source – aluminous clay (kaolin)
- Capital and operating costs are a fraction of traditional supply
- Completed **PFS** on the Cadoux Kaolin Project, progressing with **BFS**
- Developing integrated production and value chain to market

Mining / beneficiation (Cadoux) → processing / refining (Kwinana)

- FYI HPA development and production strategy means:
 - Quality, well understood and defined resource, long mine life
 - Simplified, innovative and efficient flowsheet design
 - Capex – lowest quartile per installed capacity
 - Opex - positioned in lowest industry quartile
 - Accelerated project payback anticipated

Key Achievements in FY2018

Multiple key milestones achieved towards fast-tracking production to join the HPA market

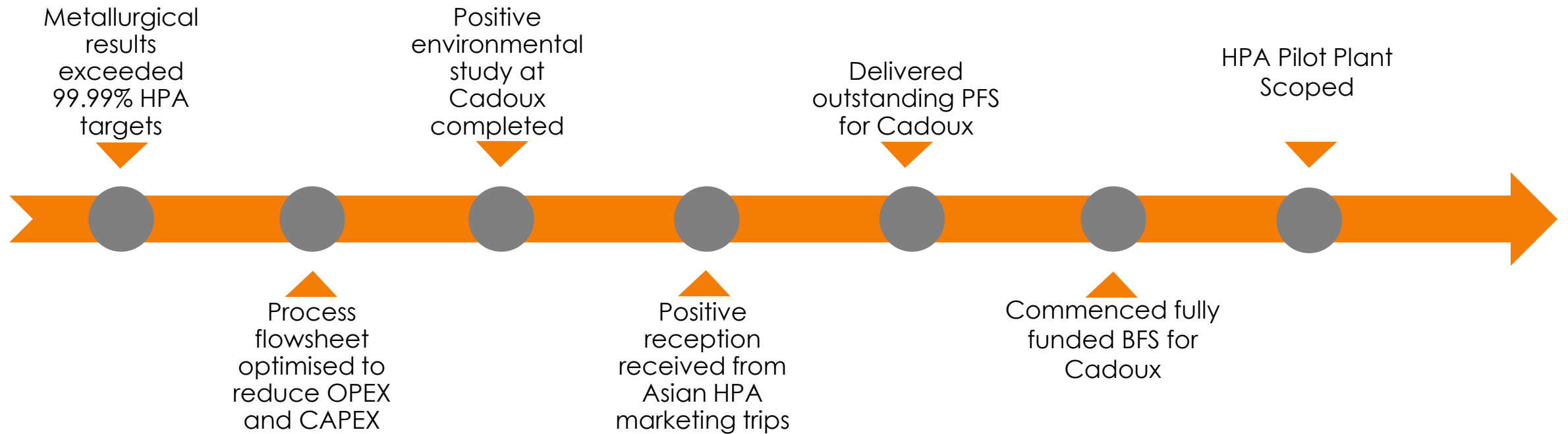

HPA Applications

HPA is a versatile material allowing a multitude of uses in new age applications

- HPA forecasts are premised on increasing consumer demand for higher specification and /or energy efficient applications
- HPA in either ceramic or sapphire glass form has excellent properties for a broad number of applications

Properties

- Purity
- Low-friction
- High wear resistance
- Hardness
- Thermal / electrical insulation
- Non-corrosive
- Inert

Applications

- LED
- EV
- Battery
- Sapphire glass
- Semiconductors / wafers
- Scratch resistant glass
- Artificial gemstones
- Aeronautics
- Space component
- High tensile fabrication
- Fine abrasives
- Electrical circuitry



HPA Market Overview

FYI's HPA strategy is based upon positive market fundamentals

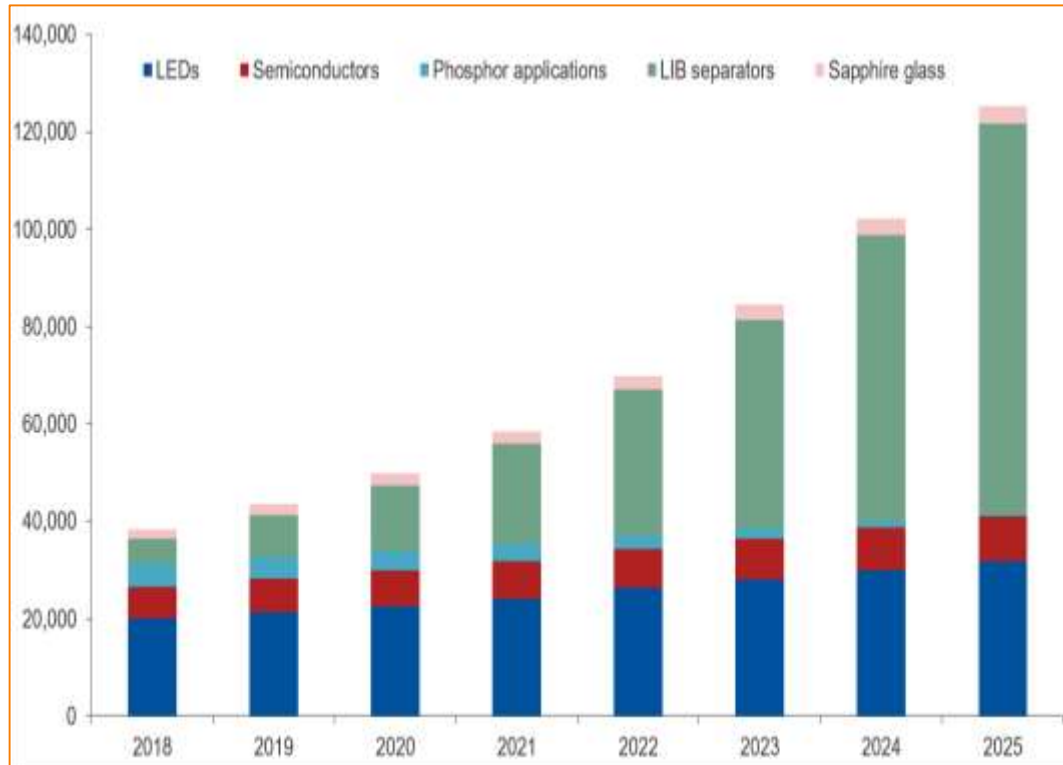

- Historically a small market – no justification for innovation
- Consistent, low-growth demand previously; new applications have created demand and new market opportunities requiring higher specification materials and guaranteed supply
- The current global 4N (99.99% Al₂O₃) HPA market demand is ~38-40k tpa; this is expected to increase to ~50k tpa by 2020 and >120k tpa by 2025*
- The market for HPA is witnessing dramatic growth / consumer driven
- HPA market forecast to be US\$4.49Bn by 2022**
- Including a forecast volume growth of 17.5% CAGR*
- HPA is experiencing increasing demand due to its significance in today's high-performance electronic devices and need for higher specification material as inputs

References: -*CRU HPA Market Research 2018

**Allied Market Research, World High Purity (HPA) – Opportunities and forecasts 2015-2022

HPA Growth and Application - LED

FYI's HPA strategy is underpinned by LED

Major industry drivers include:

- ✓ Increasing environmental awareness and strict Government power and emission policies
- ✓ Phasing out of old and inefficient technologies (eg incandescent, neon, halogen)
- ✓ Providing assurance to manufactures of a reliable and consistent supply of HPA



LED market is forecast to grow from US\$26Bn (2016) to US\$54Bn by 2022 and progressively take the major share of the global market of US\$110Bn*

Global lighting product trends (EUR billion)

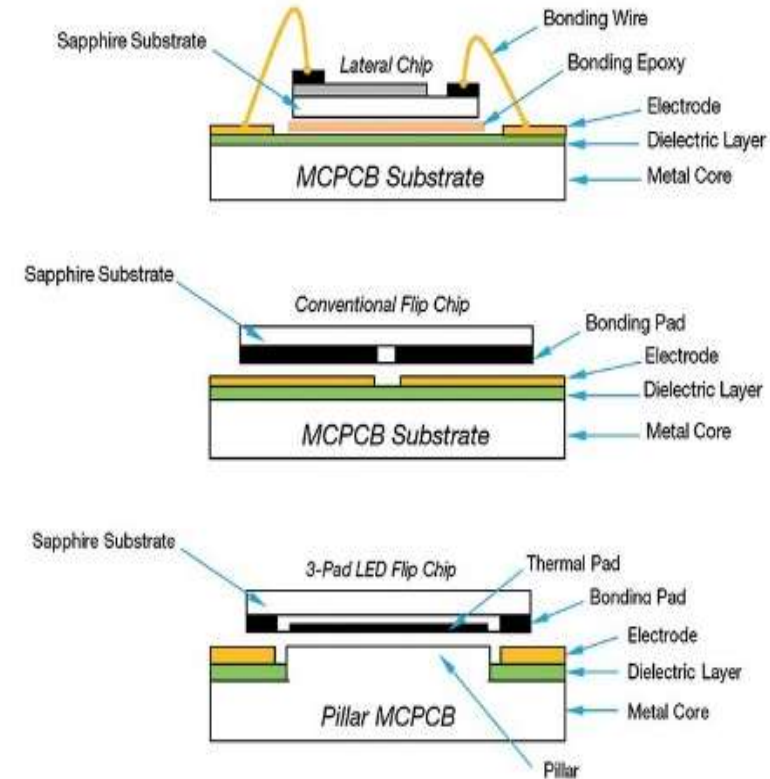
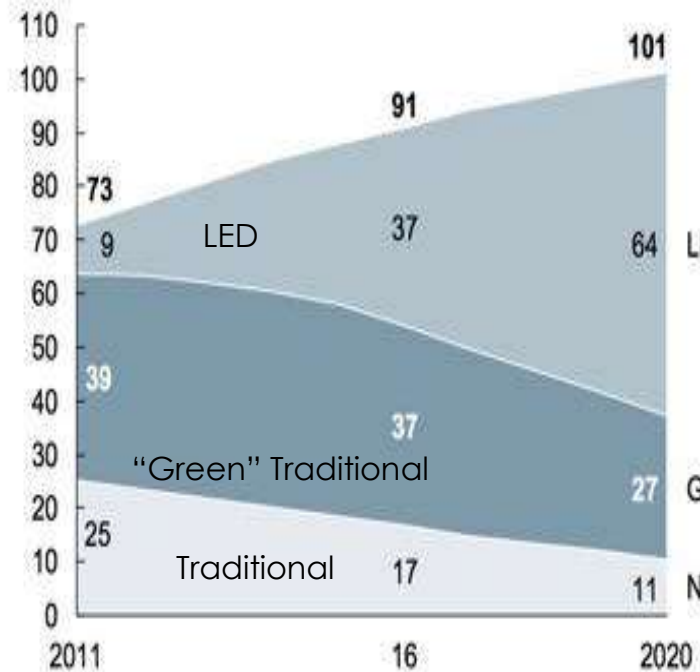

HPA Growth & Application – Battery

The EV/battery revolution provides long-term growth

Major industry drivers include:

- ✓ HPA is a major input into ceramic coated separators (CCS) in batteries
- ✓ Separators are used to prevent exothermic reactions
- ✓ Battery performance (energy density) is increasing dramatically
- ✓ CCS invented in response to increasing performance demands
- ✓ Providing greater protection, battery integrity at much higher temperatures
- ✓ Battery demand has very strong growth forecasts

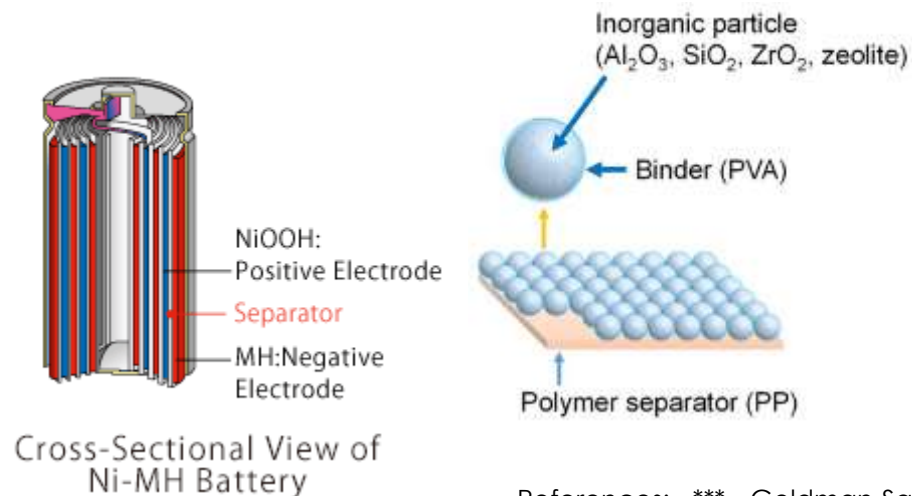
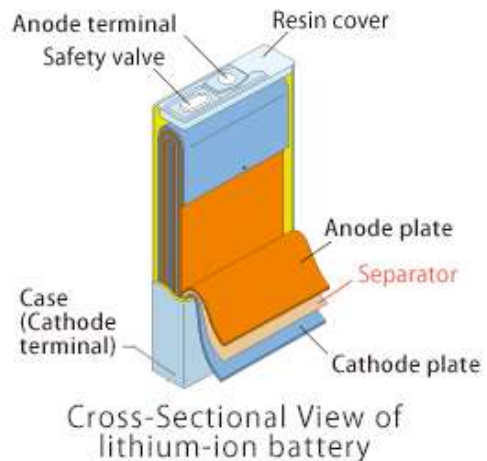

References: *** - Goldman Sachs: Electric Vehicle Boom report, September 2017

Electric Vehicle (EV) Growth

EV battery market forecast to grow from US\$450Mn (2016) to US\$35Bn (2025)***

Cadoux Kaolin Project – ideal geology for HPA



Cadoux project area location and boundary outline (EL70/4673)

- The project area boasts excellent infrastructure
- Deposit geology is ideal – shallow, flat lying, low strip, free digging, homogenous excellent quality & easily accessible
- Extensive drilling / well understood geology
- Ideal characteristics quality, grade and low deleterious elements – very amenable to HPA processing
- 100% owned project (EL70/4673) no native title, permitting straightforward.
- Probable Reserve supports a mine life of >50 years

JORC (2012)	Tonnage (Mt)	Average Al ₂ O ₃ %
Indicated Resource	3.2	24.4
Inferred Resource	6.4	22.3
Total Resource	9.6	23.0
Probable Reserve	2.9	24.4

* See ASX Company announcement – 29th October 2018

The Cadoux project is ideal quality feedstock for HPA

Quality Resource

CADOUX RESOURCE – QUALITY BASE

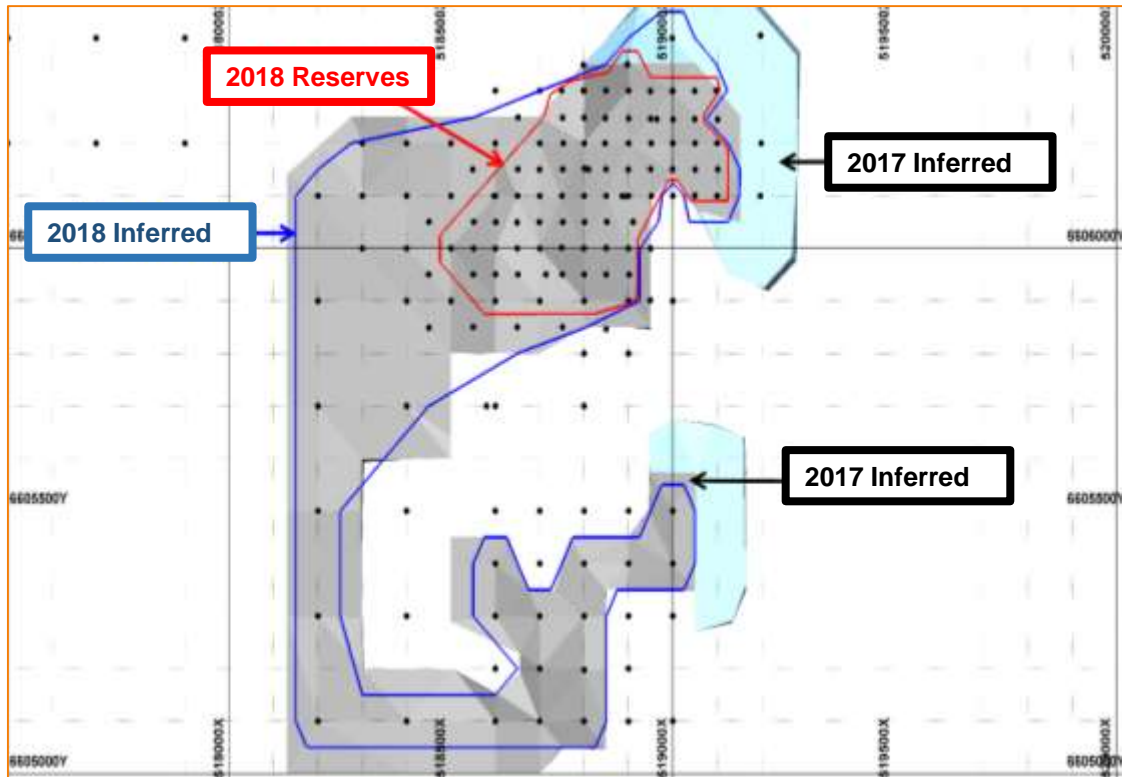

Cadoux Reserve / Resource outline (EL70/4673)

- Reserves calculated specific to optimised HPA feedstock production
- First class study managers (qualifications & experience)
- Extensive representative and variability testwork
- Very well understood resource applied to flowsheet
 - Geology
 - metallurgy
- Resulting in excellent metallurgical response
 - Grade – **99.997%** (independently verified)
 - Recovery – **97.2%**
- Over 50 years mine life (PFS modelled on 25 years)
- Assuming 100% high confidence Indicated material

Process Design

SIMPLE FLOWSHEET DESIGN LEADS TO POTENTIAL LOWEST INDUSTRY CAPEX AND OPEX

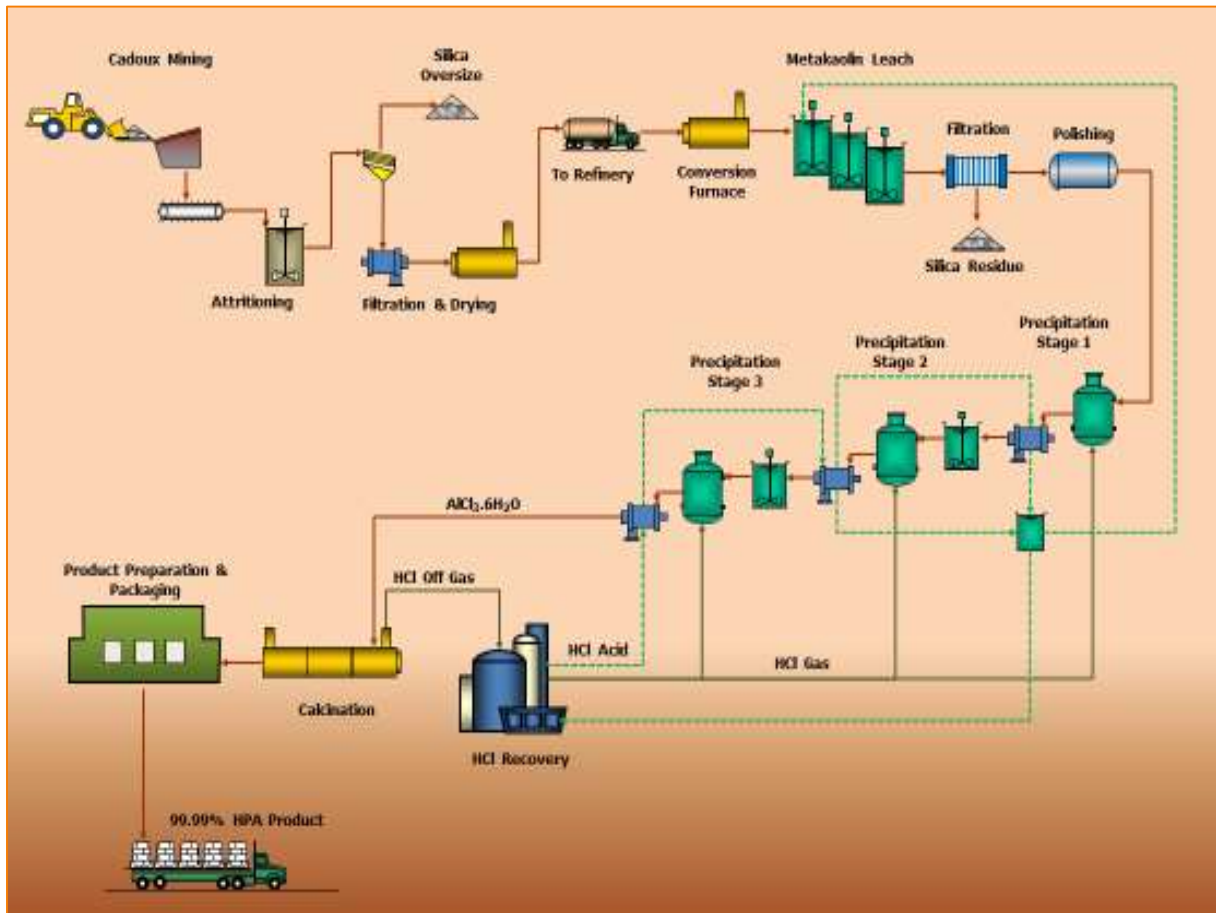

FYI's HPA flowsheet design proposed for Kwinana

- Flowsheet tested, refined under PFS review – bespoke to Cadoux
- Developed for Cadoux's quality and characteristics
- Open chemistry applied to test work
- Designed for efficiency, high specification and long life
- Successfully demonstrated (grade, recovery, efficiency)
- Utilising 'off the shelf' components
- Atmospheric pressure
- Moderate temperature
- Recycling of major inputs and outputs (ie HCl, heat (steam) etc)
- Small footprint / efficient processing circuit
- Low environmental impact (non-toxic / benign waste)
- Processing plant planned for WA's "Battery Alley" (Kwinana/Rockingham)
- **Planned lowest industry capex and low opex**

Outstanding PFS Results

Item	unit	Amount
HPA production	tpa	8,000 (with capacity to expand)
Production grade	Al ₂ O ₃	> 99.99%
Capital cost	US\$m	178.8
Capital cost / t	US\$/t	22,344
Forecast average cost of production (C1)	US\$/t	6,467
Assumed HPA selling price / t	US\$/t	24,000
Operating margin	US\$/t	17,533
Operating margin	%	~270
Exchange rate	A\$:US\$	0.75
Average annual EBITDA	US\$m	128
First phase of operations - total revenue (>50 years)	US\$m	11,376
First phase of operation - annual revenue	US\$m	190
Project NPV	@10%	506
Project IRR	%	46
Project payback	yrs	3.6

- PFS outcomes are based on:
 - Detailed and extensive technical inputs
 - Conservative assumptions
- PFS review - “All-in” cost basis, includes:
 - Cadoux, Kwinana, civils, transport, maintenance etc
- Resulting lowest sector quartile outcomes:
 - ✓ opex US\$6467/t
 - ✓ capex of US\$178m
 - ✓ Low capital intensity of US\$22,344/t
 - All-in NPV₁₀ of US\$506m
 - IRR of 46%
 - Margin US\$17,533/t
 - Project payback of 3.6 years
- Modelled using:
 - Conservative discount (10%)
 - Conservative (low) selling price (\$24,000)

FYI PFS Sensitivity Analysis

When using higher basket price of \$26,000/tonne, the economics further emphasise the world class nature of the Cadoux Kaolin Project

Item	unit	Amount		
HPA production	tpa	8,000 (with capacity to expand)		
Production grade	Al ₂ O ₃	> 99.99%		
Capital cost	US\$m	178.8		
Capital cost / t	US\$/t	22,344		
Forecast average cost of production (C1)	US\$/t	6,467		
Assumed HPA selling price / t	US\$/t	26,000		
Operating margin	US\$/t	19,533		
Operating margin	%	~300		
Exchange rate	A\$:US\$	0.75		
Average annual EBITDA	US\$m	143		
First phase of operations - total revenue (modelled 25 years)	US\$m	11,376		
First phase of operation - annual revenue	US\$m	208		
Project NPV (\$US) (post tax)	@10%	846mn	@8%	1.4bn
Project IRR (post tax)	%	63	%	75
Project payback	yrs	3.1	yrs	2.9

- Using higher basket price, economics are compelling:
 - Low sector quartile:
 - opex US\$6,467/t
 - capex of US\$178m
 - Low capital intensity of US\$22,344/t
 - "All-in" NPV₁₀ of **US\$846m (post-tax)**
 - IRR of **63% (post tax)**
 - Margin US\$19,533/t
 - Project payback of 3.1 years

FYI Market Engagement

FYI is engaged in product marketing and off-take discussions

- FYI focusing on market engagement
- Structured approach to achieving off-take and financing
- Multiple rounds of meetings conducted (China/Korea/Japan)
- Follow up meetings planned
- HPA trial product to be shipped on request to market participants (HPA manufacturers, traders)

Funding options

- FYI is examining a number of funding options to finance its future activities and development costs. These include:
 - Off-take
 - Joint venture
 - Cornerstone investor
 - Project debt
 - Equity

Total HPA Demand Forecast for 2025		
Forecaster	Demand (tpa)	Multiple (of FYI production)
Persistence	62,000	7.8x
Allied	86,000	10.7x
CRU	125,000	15x
Average	91,000	11.3x



FYI's 99.997% final product HPA

Cadoux Development Timeline

FYI's next steps for HPA development

PFS (completed September 2018)

FYI HAS A WELL DEFINED DEVELOPMENT SCHEDULE LEADING TO PROJECT DELIVERY

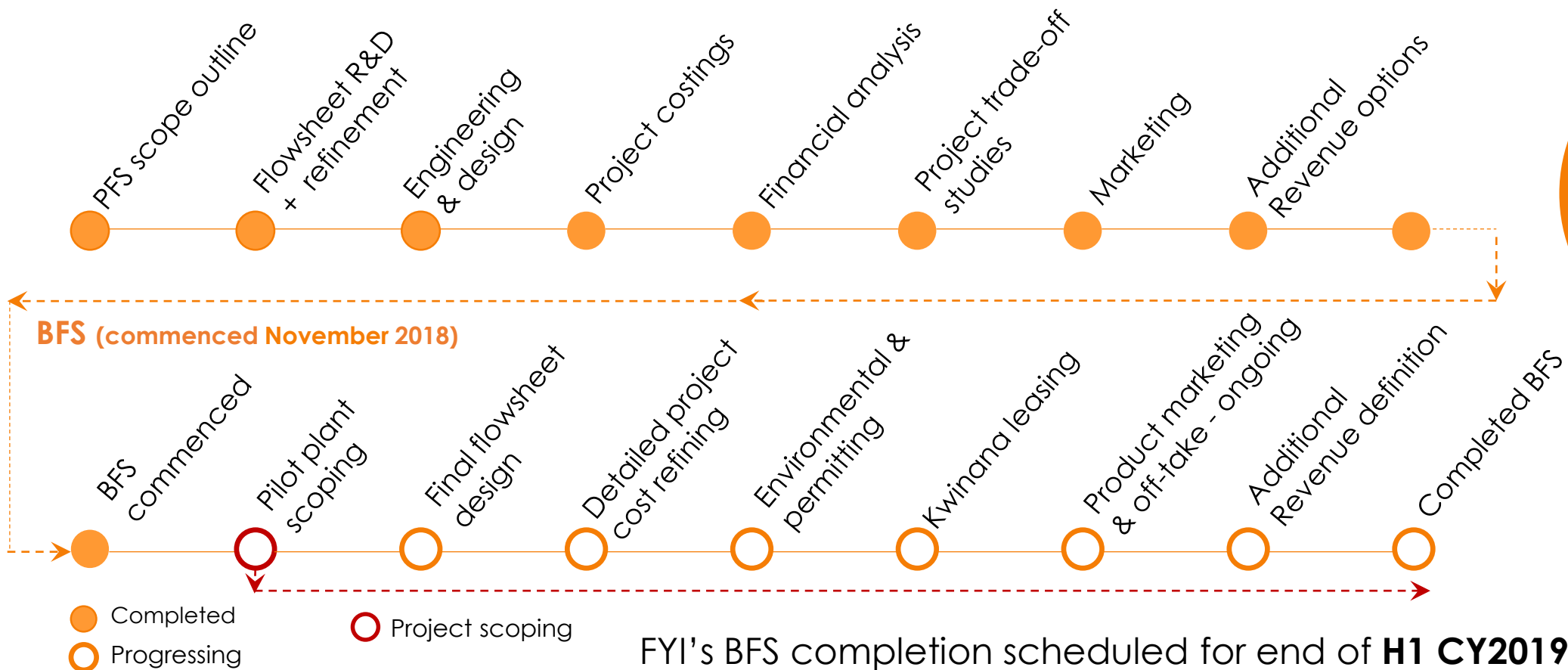

The BFS is fully funded

FYI's BFS completion scheduled for end of **H1 CY2019**

Key Objectives for FY2019

Progressing towards mine construction at the Cadoux project following an excellent PFS and commencement of a BFS.



Corporate Overview

Capital Structure

	Amount
Total issued shares	186.5m
Options (unlisted)	11.2m
Share price	\$0.074
Market cap (fully diluted)	\$13.8m
Cash as at 30 th Sept 2018	\$2.5m

Substantial Holders

	%
FYI Board & Management	16.0
Regal Funds Management	12.9
Paragon Funds Management	8.1
Top 10	~52

As at 23/11/2018

12-month Share Price Performance

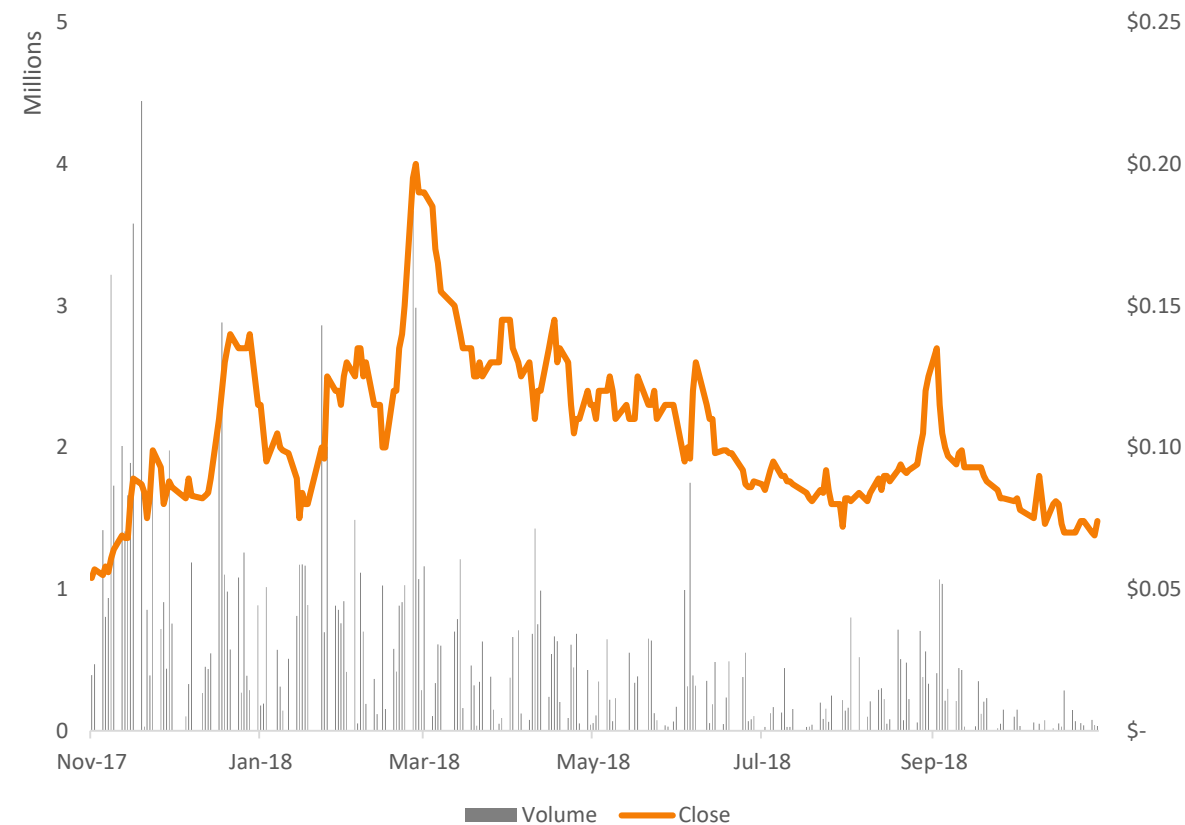

FYI Summary



ASX-listed company, fully funded to BFS



High purity alumina (HPA) Cadoux Kaolin Project in Western Australia



Positive long-term market fundamentals



Ground floor entry to an emerging growth sector



Compelling technical & geographical advantages



Experienced Board and Management



Demonstrable record of successful project development



Excellent exploration, development, operations, marketing and corporate capabilities

FYI IS DEVELOPING A LONG LIFE QUALITY ASSET AT CADOUX

Why FYI Resources?



Significant Addressable Market

- HPA demand expected to grow from 40ktpa to 120ktpa by 2025

Outstanding Project Economics

- Cadoux to produce 8ktpa of ultra high-grade HPA, delivering a 46% IRR and NPV of US\$506m

Experienced Board and Management

- Track record of successful project development

Optimised Process Design

- Simple and efficient flowsheet refined for lowest industry CAPEX and OPEX



Investor Notice

DISCLAIMER

This presentation is for information purposes only. Neither this presentation nor the information contained in it constitutes an offer, invitation, solicitation or recommendation in relation to the purchase or sale of shares in any jurisdiction. This presentation may not be distributed in any jurisdiction except in accordance with the legal requirements applicable in that jurisdiction. Recipients should inform themselves of the restrictions that apply in their own jurisdiction. A failure to do so may result in a violation of securities laws in that jurisdiction. This presentation does not constitute financial product advice and has been prepared without taking into account the recipients' investment objectives, financial circumstances or particular needs, and the opinions and recommendations in this presentation are not intended to represent recommendations to particular persons. Recipients should seek professional advice when deciding if an investment is appropriate. All securities transactions involve risks, which include, among others, the risk of adverse or unanticipated market, financial or political developments.

Certain statements contained in this presentation, including information as to the future financial or operating performance of FYI Resources Ltd ('FYI' or 'the Company') and its projects, are forward-looking statements. Such forward-looking statements are necessarily based on a number of estimates and assumptions that, while considered reasonable by FYI, are inherently subject to significant technical, business, economic, competitive, political and social uncertainties and contingencies, involve known and unknown risks and uncertainties that could cause actual events or results to differ materially from estimated or anticipated events or results reflected in such forward-looking statements, and may include, among other things, statements regarding targets, estimates and assumptions in respect of commodity prices, operating costs and results, capital expenditures, ore reserves and mineral resources and anticipated grades and recovery rates and are, or may be, based on assumptions and estimates related to future technical, economic, market, political, social and other conditions.

FYI disclaims any intent or obligation to update publicly any forward-looking statements, whether as a result of new information, future events or results or otherwise. The words 'believe', 'expect', 'anticipate', 'indicate', 'contemplate', 'target', 'plan', 'intends', 'continue', 'budget', 'estimate', 'may', 'will', 'schedule' and other, similar expressions identify forward-looking statements. All forward-looking statements made in this presentation are qualified by the foregoing cautionary statements. Investors are cautioned that forward-looking statements are not guarantees of future performance and, accordingly, investors are cautioned not to put undue reliance on forward-looking statements due to the inherent uncertainty therein. Many known and unknown factors could cause actual events or results to differ materially from estimated or anticipated events or results reflected in such forward-looking statements. Such factors include, but are not limited to: competition; mineral prices; ability to meet additional funding requirements; exploration, development and operating risks; uninsurable risks; uncertainties inherent in ore reserve and resource estimates; factors associated with foreign operations and related regulatory risks; environmental regulation and liability; currency risks; effects of inflation on results of operations; factors relating to title to properties; native title and Aboriginal heritage issues; dependence on key personnel, and share-price volatility. They also include unanticipated and unusual events, many of which it is beyond the Company's ability to control or predict.

Photographs in this presentation do not necessarily depict assets of the Company.

Investor Notice

COMPETENT PERSON'S STATEMENTS

CADOUX RESOURCES

The information in this report that relates to Mineral Resources is based on information compiled by Mr Grant Louw, under the direction and supervision of Dr Andrew Scogings, who are both full-time employees of CSA Global. Dr Scogings is a Member of the Australasian Institute of Mining and Metallurgy and a Member of the Australian Institute of Geoscientists. He is a Registered Professional Geologist in Industrial Minerals. Dr Scogings has sufficient experience relevant to the style of mineralisation and type of deposit under consideration and to the activity which he is undertaking to qualify as Competent Person as defined in the 2012 Edition of the "Australasian Code for the Reporting of Exploration Results, Mineral Resources, and Ore Reserves". The information is extracted from the PFS announcement dated 25 September 2018 and is available to view on the Company's website at www.fyiresources.com.au. The Company confirms that it is not aware of any new information or data that materially affects the information included in the original market announcements and that all material assumptions and technical parameters underpinning the findings in the relevant market announcements continue to apply and have not materially changed and that all material assumptions and technical parameters underpinning the estimate in the relevant market announcement continue to apply and have not materially changed. The Company confirms that the form and context in which the Competent Person's findings are presented have not been materially modified from the original announcement.

METALLURGY

The information in this release that relates to metallurgy and metallurgical test work is based on information reviewed and compiled by Mr Daryl Evans, a Competent Person who is a Fellow of the Australasian Institute of Mining and Metallurgy (AusIMM). Announcements in respect to metallurgical results are available to view on the Company's website at www.fyiresources.com.au. Mr Evans is an employee of Independent Metallurgical Operations Pty Ltd, and is a contractor to FYI. Mr Evans has sufficient experience that is relevant to this style of processing and type of deposit under consideration, and to the activity that he has undertaken to qualify as a Competent Person as defined in the 2012 Edition of the Australasian Code for the Reporting of Exploration Results, Mineral Resources and Ore Reserves (The JORC Code). Mr Evans consents to the inclusion of the report in the form and context in which it appears. The Company confirms that it is not aware of any new information or data that materially affects the information included in the original market announcements dated 5 September and 23 October 2017 and that all material assumptions and technical parameters underpinning the findings in the relevant market announcement continue to apply.

ORE RESERVES

The information in this report that relates to Ore Reserves is based on information compiled by Mr. Steve Craig, who is a Fellow of the Australasian Institute of Mining and Metallurgy. Steve Craig is a full-time employee of Orelogy Consulting Pty Ltd and has sufficient experience relevant to the style of mineralisation and type of deposit under consideration and to the activity which they are undertaking to qualify as a Competent Person as defined in the 2012 Edition of the "Australasian Code for Reporting of Exploration Results, Mineral Resources and Ore Reserves". The information is extracted from the announcements dated 23 and 29 October 2018 and are available to view on the Company's website at www.fyiresources.com.au. The Company confirms that it is not aware of any new information or data that materially affects the information included in the original market announcements and that all material assumptions and technical parameters underpinning the findings in the relevant market announcements continue to apply and have not materially changed and that all material assumptions and technical parameters underpinning the estimate in the relevant market announcement continue to apply and have not materially changed. The Company confirms that the form and context in which the Competent Person's findings are presented have not been materially modified from the original announcement.

Investor Notice

CAUTIONARY STATEMENTS

Substance of PFS

The PFS referred to in this announcement is a study of the potential viability of the Cadoux Project. It has been undertaken to understand the technical and economic viability of the Project.

The PFS is based on the material assumptions outlined in the PFS announcement released to ASX on 25 September 2018 and summarised in the Summary of Material Assumptions and Modifying Factors description and tables (appendix 2 and 3) attached to the PFS document. These include assumptions about the availability of funding. While the Company considers all of the material assumptions to be based on reasonable grounds, there is no certainty that they will prove to be correct or that the range of outcomes indicated by this PFS will be achieved.

To achieve the range of outcomes indicated in the PFS funding in the order of US\$197 million will likely be required. Investors should note that there is no certainty that the Company will be able to raise the amount of funding when needed. It is also possible that such funding may only be available on terms that may be dilutive to or otherwise affect the value of the Company's existing shares.

It is also possible that the Company could pursue other "value realisation" strategies such as a sale, partial sale or joint venture of the Project. If it does, this could materially reduce the Company's proportionate ownership of the Project. Given the uncertainties involved, investors should not make any investment decisions based solely on the results of the PFS.

The Company confirms that all material assumptions underpinning the results of the PFS released to ASX on 25 September 2018 and the ore reserve announced 23 and 29 October 2018 continue to apply and have not materially changed.

General and forward-looking statements

The contents of this announcement reflect various technical and economic conditions, assumptions and contingencies which are based on interpretations of current market conditions at the time of writing. Given the nature of the resources industry, these conditions can change significantly and without notice over relatively short periods of time. Consequently, actual results may vary from those detailed in this announcement.

Some statements in this announcement regarding estimates or future events are forward-looking statements. They include indications of, and guidance on, future earnings, cash flow, costs and financial performance. Such forward-looking statements are provided as a general guide only and should not be relied on as a guarantee of future performance. When used in this announcement, words such as, but are not limited to, "could", "planned", "estimated", "expect", "intend", "may", "potential", "should", "projected", "scheduled", "anticipates", "believes", "predict", "foresee", "proposed", "aim", "target", "opportunity", "nominal", "conceptual" and similar expressions are forward-looking statements. Although the Company believes that the expectations reflected in these forward-looking statements are reasonable, such statements involve risks and uncertainties, and no assurance can be given that actual results will be consistent with these forward-looking statements.

The contents of this release are also subject to significant risks and uncertainties that include but are not limited to those inherent in mine development and production, geological, mining, metallurgical and processing technical problems, the inability to obtain and maintain mine licences, permits and other regulatory approvals required in connection with mining and processing operations, competition for among other things, capital, acquisitions of reserves, undeveloped lands and skilled personnel, incorrect assessments of the value of projects and acquisitions, changes in commodity prices and exchange rates, currency and interest rate fluctuations and other adverse economic conditions, the potential inability to market and sell products, various events which could disrupt operations and/or the transportation of mineral products, including labour stoppages and severe weather conditions, the demand for and availability of transportation services, environmental, native title, heritage, taxation and other legal problems, the potential inability to secure adequate financing and management's potential inability to anticipate and manage the foregoing factors and risks.

All persons should consider seeking appropriate professional legal, financial and taxation advice in reviewing this announcement and all other information with respect to the Company and evaluating the business, financial performance and operations of the Company. Neither the provision of this announcement nor any information contained in this announcement or subsequently communicated to any person in connection with this announcement is, or should be taken as, constituting the giving of investment or financial advice to any person. This announcement does not take into account the individual investment objective, financial or tax situation or particular needs of any person.



For further details please contact:

Roland Hill

Managing Director
FYI Resources

+61 8 9361 3100

info@fyiresources.com.au

www.fyiresources.com.au

53 Canning Highway Victoria Park WA 6100

ASX: **FYI**

